



Serie KTP Terminali Isolati a Tubetto  
KTP Series Insulated Core End Terminals

ACCESSORIES

ACCESSORI

Codice	Dimensioni						Sez. Cavo mm <sup>2</sup>	Colore	Imb.		
	F mm	L mm	W mm	B mm	D mm	C mm					
KTP0506	6	12	2,5	6	1,3	1	0,5		500		
KTP0508	8	14						W	A	W	500
KTP0510	10	16									500
KTP0512	12	18									500
KTP7506	6	12,4	2,8	6,4	1,5	1,2	0,75		500		
KTP7508	8	14,6						B	W	G	500
KTP7510	10	16,4									500
KTP7512	12	18,4									500
KTP1006	6	12,4	3	6,4	1,7	1,4	1		500		
KTP1008	8	14,6						R	Y	R	500
KTP1010	10	16,4									500
KTP1012	12	18,4									500
KTP1508	8	14,6	3,5	6,4	2	1,7	1,5		500		
KTP1510	10	16,4						N	R	N	500
KTP1512	12	18,4									500
KTP2508	8	15,2						4	7	2,6	2,3
KTP2510	10	18	G	B	B	500					
KTP2512	12	19				500					
KTP4009	9	16,5	4,4	7,5	3,2	2,8	4				
KTP4012	12	16,5						A	G	G	500
KTP4018	18	19,5									500

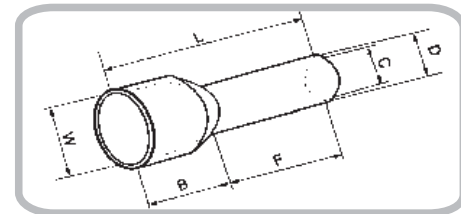

Temp di utilizzo : 105°C

Materiali : Rame PVC

Ui : 300V

KTP6012	12	20	6,3	8	3,9	3,5	6	V	N	Y	500
KTP6018	18	26									
KTP10012	12	21,5	7,6	9,5	4,9	4,5	10	M	AV	R	300
KTP10018	18	27,5									
KTP16012	12	22,2	8,8	10,2	6,2	5,8	16	AV	V	B	300
KTP16018	18	28,2									
KTP25012	12	23	11,2	13	7,9	7,5	25				200
KTP25016	16	29						N	M	Y	200
KTP25018	18	33									200
KTP25022	22	35									200
KTP35016	16	30	12,7	14	8,7	8,3	35				100
KTP35018	18	33						R	V	R	100
KTP35025	25	39									100
KTP50020	20	36	15,3	16	10,9	10,3	50	B	O	B	100
KTP50025	25	41									100
KTP70020	20	36	17,5	17	14,4	13,6	70		Y		50
KTP70025	25	41									50
KTP95025	25	44	20	19	15,4	14,5	95		R		50
KTP12027	27	47,4	22	20	17,6	16,5	120		B		50

Legenda Colori: A= Arancio , W= Bianco , B=Blue , G= Grigio , R=Rosso , Y=Giallo ,  
N=Nero , V=Verde , AV=Avorio , M=Marrone , O=Oliva



MORSETTERIA  
1.0



ACCESSORI  
2.0



GUIDE DIN  
3.0



IMPIANTI TERRA  
4.0



## Serie KTD Terminali Tubetto Doppi Preisolati

### KTD Series Insulated Core End Double Terminals

Codice	Dimensioni						Sez. Cavo mm <sup>2</sup>	Colore			Imb.
	F mm	L mm	W mm	B mm	DØ mm	CØ mm		W	A	V	
KTD0508	8	14,5	5	6,5	1,8	1,5	2x0,5	W	A	V	500
KTD7508	8	14,7	5,5	6,7	2,1	1,8	2x0,75	B	W	V	500
KTD7510	10	16,7	5,5	6,7	2,1	1,8	2x0,75	B	W	V	500
KTD1008	8	15,1	5,5	7,1	2,3	2	2x1,0	R	A	V	500
KTD1010	10	17,1	5,5	7,1	2,3	2	2x1,0	R	A	V	500
KTD1508	8	15,5	6,4	7,2	2,6	2,3	2x1,5	N	R	V	500
KTD1512	12	19,5	6,4	7,5	2,6	2,3	2x1,5	N	R	V	500
KTD2510	10	18,5	8	8,5	3,3	2,9	2x2,5	G	B	V	500
KTD2513	13	21,5	8	8,5	3,3	2,9	2x2,5	G	B	V	500
KTD4012	12	23,1	8,8	11,1	4,2	3,8	2x4,0	A	G	V	300
KTD6014	14	26,1	9,5	12,1	5,3	4,9	2x6,0	N	V	V	300
KTD10014	14	26,6	12,6	12	6,9	6,5	2x10,0	M	AV	V	200
KTD16014	14	31,3	19	17,3	8,7	8,3	2x16,0	AV	V	V	200

Legenda Colori: A=Arancio, W=Bianco, B=Blue, G=Grigio, R=Rosso, Y=Giallo,  
N=Nero, V=Verde, AV=Avorio, M=Marrone, O=Olive

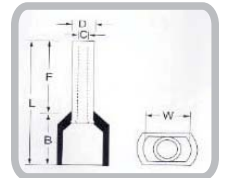
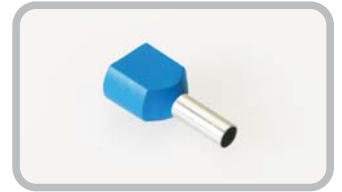

Temp di utilizzo : 105°C  
Materiale : Rame PVC  
Ui : 300V

**RoHS**  
Compliant

## Serie KTN Terminali Tubetto Nudi

### KTN Series Not Insulated Core End Terminals

Materiale : Rame Temp. 105°C U i 300V

Codice	Dimensioni					Sez. Cavo mm <sup>2</sup>	Imb
	L mm	D mm	C mm	B mm	W mm		
KTN0506	6	1,3	1	0,7	2,1	0,5	500
KTN7506	6	1,5	1,2	0,7	2,5	0,75	500
KTN1006	6						500
KTN1010	10	1,7	1,4	0,7	2,7	1	500
KTN1508	8						500
KTN1510	10	2	1,7	1	2,9	1,5	500
KTN2508	8						500
KTN2512	12	2,5	2,2	1	3,3	2,5	500
KTN4009	9						500
KTN4012	12	3,2	2,8	1	4	4	500
KTN6010	10						300
KTN6012	12	3,9	3,5	1	4,8	6	300
KTN10012	12						300
KTN10015	15	4,9	4,5	1,2	5,8	10	300
KTN10018	18						300
KTN16012	12						300
KTN16015	15	6,2	5,8	1,5	7,5	16	300
KTN16018	18						300
KTN25016	16						100
KTN25022	22	7,9	7,5	1,8	9,2	25	100
KTN35018	18	8,5	8,3	2	11	35	100
KTN50022	22	10,6	10,3	2,2	13	50	100
KTN70025	25	14,4	13,6	2,3	17	70	50
KTN95020	20	15,4	14,5	2,5	18	95	50
KTN120032	32	17,6	16,5	2,7	20	120	50

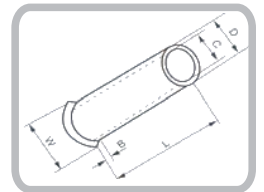

**RoHS**  
Compliant



# Serie KCP Capicorda Preisolati

## KCP Series Insulated Ring Terminals

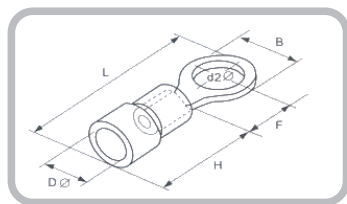

**RoHS**  
Compliant

ACCESSORIES

ACCESSORI

Temp di utilizzo : 105°C  
Materiali : Rame PVC



Codice	Dimensioni						Corr A	Sez. cavo mm <sup>2</sup>	Colore	Imb.					
	D <sup>2</sup> mm	B mm	L mm	F mm	H mm	DØ mm									
KCP125032	3,2	5,7	18,3	5	10,5	4,3	19A	0,5-1,5	R	500					
KCP125037C	3,7	5,7	18,3	5						500					
KCP125037L	3,7	8	22	7						500					
KCP125040C	4,3	6,6	21,6	6,3						500					
KCP125040L	4,3	8	22	7						500					
KCP125050C	5,3	8	22	7						500					
KCP125050L	5,3	9,8	23,5	8						500					
KCP125060	6,5	11,6	28	11,1						500					
KCP125080	8,4	11,6	28	11,1						500					
KCP125100C	10,5	13,6	32,1	13,9						500					
KCP125100L	10,5	17,5	34,5	15,2						500					
KCP125120	13	17,5	34,5	15,2						500					
KCP125160	16,5	24,5	44,2	21,8						500					
KCP200032	3,2	6,6	19,5	5,7						10,5	4,9	27A	1,5-2,5	B	500
KCP200037C	3,7	6,6	18,3	4,3											500
KCP200037L	3,7	8,5	23	7,8	500										
KCP200040C	4,3	6,6	22	8,5	500										
KCP200040L	5,3	8,5	23	7,8	500										
KCP200050C	5,3	9,5	23	7,3	500										
KCP200050L	6,5	12	28,1	11	500										
KCP200060	8,4	12	28,1	11	500										
KCP200080	10,5	13,6	30,7	13,9	500										
KCP200100C	10,5	17,5	34,5	15,2	500										
KCP200100L	13	17,5	34,5	15,2	500										
KCP200120	13	19,2	36,4	16,3	500										
KCP350040	4,3	8	25,5	7,7	13,5	6,2	37A	2,5-4	N	500					
KCP350050C	5,3	8	25,5	7,7						500					
KCP350050L	6,5	12	28,9	7,7						500					
KCP350060	8,5	15	33,5	13						500					
KCP350080	10,5	15	33,5	13						500					
KCP350100	10,5	15	36,4	13						500					
KCP550037	3,7	7,2	22,4	5,9	13,5	6,7	48A	4-6	Y	500					
KCP550040C	4,3	7,2	22,4	5,9						500					
KCP550040L	4,3	9,5	26,5	8,3						500					
KCP550050	5,3	9,5	26,5	8,3						500					
KCP550060	6,5	12	32,5	13						500					
KCP550100	10,5	15	34,7	13,7						500					
KCP550120	13	19,2	39,1	16						500					



MORSETTERIA  
1.0



ACCESSORI  
2.0



GUIDE DIN  
3.0



IMPIANTI TERRA  
4.0



## Serie KFP Forcelle Preisolate

### KFP Series Insulated Spade Terminals

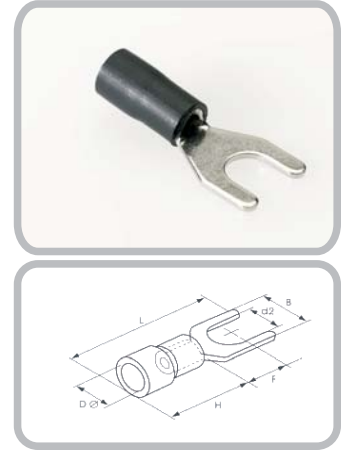

Temp di utilizzo : 105°C  
Materiali : Rame PVC

ACCESSORI

ACCESSORIES

Codice	Dimensioni						Corr A	Sez. cavo mm <sup>2</sup>	Colore	Imballo
	D <sup>2</sup> mm	B mm	L mm	F mm	H mm	DØ mm				
KFP125032	3,2	5,7	21,8	6,5	10,5	4,3	19A	0,5-1,5	R	500
KFP125037C	3,7	5,7	21,8	6,5						500
KFP125037L	3,7	6,4	21,8	6,5						500
KFP125040C	4,3	6,4	21,8	6,5						500
KFP125040L	4,3	8,1	21,8	6,5						500
KFP125050C	5,3	8,1	21,8	6,5						500
KFP125050L	5,3	9,5	21,8	6,5						500
KFP125060C	6,5	9,5	21,8	6,5						500
KFP125060L	6,5	11	25,8	9,8						500
KFP125080	8,5	14,5	30,5	12,6						500
KFP200032	3,2	5,7	21,8	6,5	10,5	4,9	27A	1,5-2,5	B	500
KFP200037C	3,7	5,7	21,8	6,5						500
KFP200037L	3,7	6	21,8	6,5						500
KFP200040C	4,3	6,4	21,8	6,5						500
KFP200040M	4,3	7,2	21,8	6,5						500
KFP200040L	4,3	8,1	21,8	6,5						500
KFP200050C	5,3	8,1	21,8	6,5						500
KFP200050L	5,3	9,5	21,8	6,5						500
KFP200060C	6,5	9,5	21,8	6,5						500
KFP200060L	6,5	12	27,8	11						500
KFP200080	8,5	14,5	30,5	12,6	500					
KFP350040	4,3	8	25,8	7,7	13,5	6,2	37A	2,5-4	N	500
KFP350050	5,3	8	25,8	7,7						500
KFP350060	6,5	12	29	12,1						500
KFP550037	3,7	8,3	26,2	7,5	13,5	6,7	48A	4-6	Y	500
KFP550040C	4,3	8,3	26,2	7,5						500
KFP550040L	4,3	9	24,9	7,5						500
KFP550050	5,3	9	24,9	7,5						500
KFP550060C	6,5	9	24,9	7,5						500
KFP550060L	6,5	12	32,2	12						500
KFP550080	8,4	14	31	11,5						500

2.18



MORSETTERIA  
1.0



ACCESSORI  
2.0



GUIDE DIN  
3.0



IMPIANTI TERRA  
4.0

## Serie KPF Innesti Femmina

### KPF Series Insulated Female Terminals



ACCESSORIES

ACCESSORI

Codice	Dimensioni					Piastrina mm	Spes mm	Sez. Cavo mm <sup>2</sup>	Corr. A	Colore	Imballo
	B mm	d $\emptyset$ mm	D $\emptyset$ mm	L mm	H mm						
KPF125115	3,8	1,7	3,8	19	10	0,5X2,8	0,3	0,5-1,5	10A	R	500
KPF125118	3,8	1,7	3,8	19		0,8X2,8	0,3				500
KPF125185	5,6	1,7	3,8	19		0,5X4,75	0,35				500
KPF125188	5,6	1,7	3,8	19		0,8X4,75	0,35				500
KPF125250	7,4	1,7	3,8	21		0,8X6,35	0,4				500
KPF200115	3,8	2,3	4,3	19	10	0,5X2,8	0,3	1,5-2,5	15A	B	500
KPF200118	3,8	2,3	4,3	19		0,8X2,8	0,3				500
KPF200185	5,6	2,3	4,3	19		0,5X4,75	0,35				500
KPF200188	5,6	2,3	4,3	19		0,8X4,75	0,35				500
KPF200250	7,4	2,3	4,3	21		0,8X6,35	0,4				500
KPF550250	7,4	3,4	5,7	25	12,5	0,8X6,35	0,4	4-6	24A	Y	500

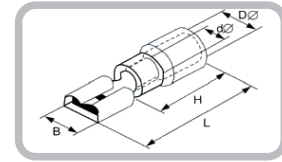

Materiali: Rame PVC

## Serie KPM Innesti Maschio

### KPM Series Insulated Male Terminals

Codice	Dimensioni					Piastrina mm	Spes mm	Sez. Cavo mm <sup>2</sup>	Corr. A	Colore	Imballo
	B mm	d $\emptyset$ mm	D $\emptyset$ mm	L mm	H mm						
KPM125118	2,8	1,7	3,8	17,7	10	0,8X2,8	0,8	0,5-1,5	10A	R	500
KPM125185	4,75	1,7	3,8	20		0,5X4,75	0,5				500
KPM125188	4,75	1,7	3,8	18,5		0,8X4,75	0,4				500
KPM125250	6,35	1,7	3,8	21		0,8X6,35	0,4				500
KPM200185	4,75	2,3	4,3	20	10	0,5X4,75	0,5	1,5-2,5	15A	B	500
KPM200188	4,75	2,3	4,3	18,5		0,8X4,75	0,4				500
KPM200250	6,35	2,3	4,3	21		0,8X6,35	0,4				500
KPM550250	6,4	3,4	5,7	25		12,5	0,8X6,35				0,4

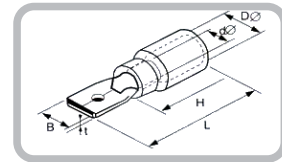

Materiali: Rame PVC

## Serie KMF Innesti Maschio/ Femmina

### KMF Series Flat Insulated Male&Female Connectors

B1=6,3 mm

Codice	Dimensioni					Piastrina mm	Sez. Cavo mm <sup>2</sup>	Corr. A	Colore	Imballo
	B mm	H mm	D $\emptyset$ mm	d $\emptyset$ mm	L mm					
KMF125250	7,4	10	3,8	1,7	21,5	0,8X6,35	0,5-1,5	10A	R	500
KMF200250	7,4	10	4,3	2,3	21,5	0,8X6,35	1,5-2,5	15A	B	500
KMF550250	7,4	12,5	5,7	3,4	25	0,8X6,35	4-6	24A	Y	500

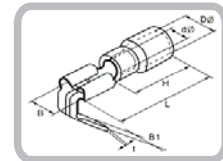

Materiali: Rame PVC

## Serie KFI Connettori Femmina Totalmente Isolati

### KFI Series Fully Insulated Female Connectors

Codice	Dimensioni					Piastrina mm	Sez. Cavo mm <sup>2</sup>	Corr. A	Colore	Imballo
	W mm	B mm	D $\emptyset$ mm	d $\emptyset$ mm	L mm					
KFI125185	7,6	5,6	3,8	1,7	20	0,5X4,75	0,5-1,5	10A	R	500
KFI125188	7,6	5,6	3,8	1,7	20	0,8X4,75				500
KFI125250	9,4	7,4	3,8	1,7	21,5	0,8X6,35				500
KFI200185	7,6	5,6	4,3	2,3	20	0,5X4,75	1,5-2,5	15A	B	500
KFI200188	7,6	5,6	4,3	2,3	20	0,8X4,75				500
KFI200250	9,4	7,4	4,3	2,3	21,5	0,8X6,35				500
KFI550250	9,4	7,4	5,7	3,4	25,5	0,8X6,35	4-6	24A	Y	500

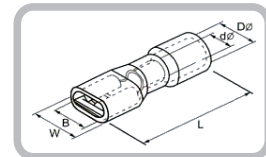

Materiali: Rame PVC



MORSETTERIA  
1.0



ACCESSORI  
2.0



GUIDE DIN  
3.0



IMPIANTI TERRA  
4.0



## Serie KGH Giunti di testa e Serie KGP Giunti Paralleli Preisolati

### KGH and KGP Series Insulated Butt Parallel Connectors

Codice	Dimensioni			Corr A	Sez. cavo mm <sup>2</sup>	Colore		Imballo
	l mm	Dø mm	L mm					
KGH125	15	4,4	26	19A	0,5-1,5	R		500
KGH200	15	5,1	26	27A	1,5-2,5	B		500
KGH550	15	6,8	26	48A	4-6	Y		500
KGH800	21	8,5	32	62A	6-10	R		500
KGP125	8	4,4	16	19A	0,5-1,5	R		500
KGP200	8	5,1	16	27A	1,5-2,5	B		500
KGP550	8,5	6,8	20,5	48A	4-6	Y		500

Materiali: Rame PVC

## Serie KTT Terminali Tondi Preisolati

### KTT Series Insulated Pin Terminals

Codice	Dimensioni				Sez. cavo mm <sup>2</sup>	Corr A	Col	Imballo
	Fø mm	L mm	H mm	Dø mm				
KTT12510	1,9	20	10	4,3	0,5-1,5	19A	R	500
KTT12512	1,9	22	10	4,3				
KTT20010	1,9	20	10	4,9	1,5-2,5	27A	B	500
KTT20012	1,9	22	10	4,9				
KTT55013	2,8	25,5	12,5	6,7	4-6	48A	Y	500

Materiali: Rame PVC

## Serie KPP Terminali Piatti Preisolati

### KPP Series Insulated Lipped Blade Terminals

Codice	Dimensioni				Sez. cavo mm <sup>2</sup>	Corr A	Col	Imballo
	W mm	L mm	F mm	C mm				
KPP12510	2,3	20	10	4,3	0,5-1,5	19A	R	500
KPP12511	3	21	11					
KPP12514	3	24	14					
KPP12518	2,3	28	18					
KPP20010	2,8	19	9	4,9	1,5-2,5	27A	B	500
KPP20014	3	24	13					
KPP20018	2,3	28	18					
KPP55010	2,8	22,5	10					
KPP55014	4,5	27,5	14	6,7	4-6	48A	Y	500

Materiali: Rame PVC

## Serie KCM Innesti Cilindrici Maschio

### KCM Series Bullet Type Insulated Connectors

Codice	Dimensioni							Sez. Cavo mm <sup>2</sup>	Corr. A	Colore		Imballo
	bø	F	Dø	dø	H	L	Spes					
	mm	mm	mm	mm	mm	mm	mm					
KCM125156	4	11	3,8	1,7	10	21	0,4	0,5-1,5	10A	R		500
KCM200156	4		4,3	2,3				B		500		
KCM200195	5		1,5-2,5	15A				B		500		
KCM550156	4	11	5,7	3,4	12,5	25	0,4	4-6	24A	Y		500
KCM550195	5									Y		500

Materiali: Rame PVC

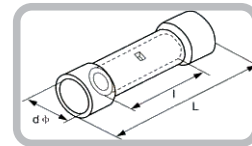

RoHS  
Compliant  
CE

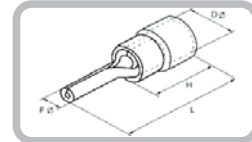

RoHS  
Compliant  
CE

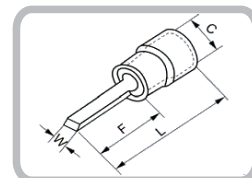

RoHS  
Compliant  
CE

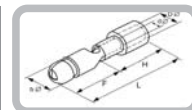

RoHS  
Compliant  
CE



## Serie KCF Innesti Cilindrici Femmina

KCF Series Bullet Female Connectors

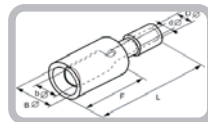

ACCESSORIES

ACCESSORI

Materiali : Rame PVC

Codice	Dimensioni						Spes mm	Sez. Cavo mm <sup>2</sup>	Corr. A	Colore	Imballo
	b∅	B∅	D∅	d∅	F	L					
	mm	mm	mm	mm	mm	mm					
KCF125156	4	6,3	3,8	1,7	13	24,5	0,4	0,5-1,5	10A	R	500
KCF200156	4	6,3	4,3	2,3	14	24,5		1,5-2,5	15A	B	500
KCF200195	5	7	4,3	2,3	14	24,5		4-6	24A	B	500
KCF550156	4	7	5,7	3,4	14	27	0,4	4-6	24A	Y	500
KCF550195	5	7	5,7	3,4	14	29				Y	500

## Serie KCC Conncettori Di Coda

KCC Series Nylon Wire Joints

Materiali : Rame PA Nylon

Co di ce	Dimensioni				Sez. Cavo mm	Colore	Imballo
	d∅ mm	D∅ mm	∅ C mm	L mm			
KCC125	2,4	8,25	9,75	20,1	0,25-1,5		500
KCC200	3	8,25	9,75	20,1	1,5-2,5	Nylon	500
KCC550	4	10,5	12,5	25,5	1,5-2,5	Neutro	500
KCC800	4,8	12	14	27,3	4-6		500

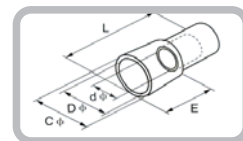

## Serie KCR Connettori Rapidi-Rubacorrente

KCR Series Fast Connecting Connectors

Codice	Dimensioni		Sezione Cavi mm <sup>2</sup>	Colore	Imballo
	W mm	L mm			
KCR1253	20	32	0,5-1,5	R	300
KCR2003	20	32	1,5-2,5	B	300
KCR5503	20	32	4-6	Y	300

Materiali: Rame PVC

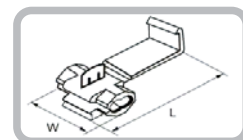

Legenda COLORI

A=Arancio  
W=Bianco  
B=Blue  
G=Grigio  
R=rosso  
Y=Giallo

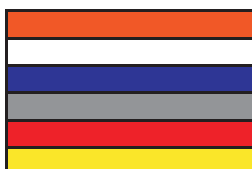

N=Nero  
Av=Avorio  
M=Marrone  
O=Oliva  
T=Trasparente  
V=Verde

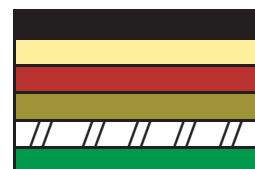

MORSETTERIA  
1.0



ACCESSORI  
2.0



GUIDE DIN  
3.0



IMPIANTI TERRA  
4.0



## Assortimento Terminali Serie KTP in Box

KTP Series Insulated Core End Terminals Selection in Box



CODICE	DESCRIZIONE	CONTENUTO	PEZZI	COLORE		IMBALLO
KTP001	Ass.Term.Tub 0,5-2,5	KTP0508W	50	BIANCO		5
		KTP7508G	100	GRIGIO		
		KTP1008R	100	ROSSO		
		KTP1508N	100	NERO		
		KTP2508B	50	BLU		
KTP004	Ass.Term.Tub 4-16	KTP4009A	50	ARANCIO		5
		KTP6012V	20	VERDE		
		KTP10012AV	20	AVORIO		
		KTP16012M	10	MARRONE		

## Assortimento Terminali Serie KTD in Box

KTD Series Insulated Core End DoubleTerminals Selection in Box



CODICE	DESCRIZIONE	CONTENUTO	PEZZI	COLORE		IMBALLO
KTD001	Ass.Term.Doppi 0,5-2,5	KTD0508W	50	BIANCO		5
		KTD7508G	100	GRIGIO		
		KTD1008R	100	ROSSO		
		KTD1508N	50	NERO		
		KTD2510B	50	BLU		
KTD004	Ass.Term.Doppi 4-16	KTD4012G	20	GRIGIO		5
		KTP6014N	10	NERO		
		KTP10014R	10	ROSSO		
		KTP16014AV	5	AVORIO		

